





SKU: BV5051

-  Brass Ball Valve with Locking Lever - Vented
-  Messingkugelventil mit Feststellhebel - Vented
-  Válvula de bola de latón con palanca de bloqueo - ventilación
-  Laiton Ball Valve avec levier de verrouillage - Ventilé

Valves[™]
O N L I N E

- 1/4 " - 2" Vented brass ball valve with locking lever - BSPP
- 1/4 " - 2" Geschlossene Messingkugelhahn mit Sperrhebel - BSPP
- 1/4 " - 2" válvula de venteo de latón pelota con mecanismo de seguridad – BSPP
- 1/4 " - 2" Ventilé laiton robinet à tournant sphérique avec levier de verrouillage - BSPP

Brass Ball Valve, Vented with Locking Lever Screwed BSPP



Description

Brass nickel plated full bore ball valve and PTFE seats - with locking device and blue lockable lever. The valve is screwed BSPP and has a M5 Tapped Vent Hole. Temperature range for fluids -10°C - +100°C Pressure rating PN14. The padlock is not included with the valve.



Beschreibung

Messing vernickelt mit vollem Durchgang Kugelhahn und PTFE-Sitzen - mit Arretierung und blau abschließbaren Hebels . Das Ventil wird BSPP verschraubt und hat eine M5 Gewinde Vent Hole. Temperaturbereich für Flüssigkeiten -10 ° C - + 100 ° C Pressure Bewertung PN14 . Das Schloss nicht mit dem Ventil enthalten.



Descripción

Latón niquelado válvula de bola y asientos PTFE paso total - con el dispositivo y azul con cierre de palanca de bloqueo . La válvula está atornillado BSPP y tiene un orificio de ventilación roscados M5 . Rango de temperatura para fluidos -10 ° C - + 100 ° C Pressure calificación Pn14 . El candado no está incluido con la válvula.







Description

Laiton nickelé passage intégral soupape de balle et PTFE sièges - avec le dispositif et le levier de verrouillage bleu verrouillable . La vanne est vissé BSPP et dispose d'un Trou de M5 taraudé . Plage de température pour les fluides de -10 ° C - + 100 ° C Pressure note PN14 . Le cadenas ne sont pas inclus avec la vanne .

- M5 Tapped Vented Hole
- Full Bore Screwed BSPP
- Lockable Lever (padlock not included)

DESCRIPTION

Brass ball valve with lockable handle that exhausts automatically when the valve is in the closed position. The valve is lockable in the closed position only, therefore allowing safe maintenance. Exceptional value for money, offering reliability and a long life.

-  Brass Ball Valve with Locking Lever - Vented
-  Messingkugelventil mit Feststellhebel - Vented
-  Válvula de bola de latón con palanca de bloqueo - ventilación
-  Laiton Ball Valve avec levier de verrouillage - Ventilé

2/2 Vented brass ball valve with locking lever

Description

Brass Nickel Plated Full Bore Ball Valve - with Locking Device (Padlock not included)
 Blue lockable lever with PVC sleeve. Screwed BSPF Female, M5 Tapped Vent Hole.
 Temperature range Fluids -10°C - +100°C
 Pressure PN14

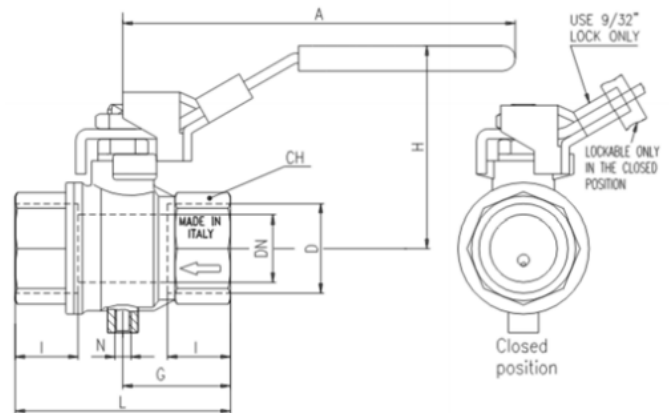

DIMENSIONS								
DN	Size	I	L	C	A	H	CH	Kg
8	1/4"	12	45	22.5	96	48	20	0.21
10	3/8"	12	45	22.5	96	48	20	0.21
15	1/2"	15.5	59	29.5	96	51	25	0.33
20	3/4"	17	64	32	117	60	31	0.5
25	1"	21	81	40.5	117	64	40	0.84
32	1 1/4"	23	93	46.5	157	80	49	1.2
40	1 1/2"	23	102	51	157	86	54	1.64
50	2"	26.5	121	60.5	157	93	68.5	2.67

Dimensions shown are for guidance only

Material List	
Body	Brass Nickel Plated
Seat	PTFE
Ball	Brass Chrome Plated
End Cap	Brass Nickel Plated
Stem	Brass Nickel Plated
Gland Nut	Brass Nickel Plated
Nut	Geomet®
Gland Seal	PTFE
Washer	PTFE
Handle	PVC Coated

Pressure / Temperature Ratings	
Pressure	PN14
Temperature	-10° C to 100° C