





SKU: BV5141

-  VOLT 3" Cast Iron Table E Ball Valve
-  VOLT 3" Cast Iron Table E - Kugelhahn
-  VOLT 3" Reparto de la Tabla válvula de bola E Hierro
-  VOLT 3" Fonte Tableau E Ball Valve

Valves[™]
O N L I N E

- 3" Cast Iron Table E Flanged Ball Valve
- 3" Cast Iron Table E Flansch-Kugelhahn
- 3" Reparto de la válvula de bola con bridas de hierro Tabla E
- 3" Fonte Tableau E bride Ball Valve



3" Table E Cast Iron Ball Valve

- **Size 3"**
- **Table E**
- **-10° C to 70° C**
- **Lever Operated**
- **PN16 Rated**
- **PTFE Seats**

Description

Cast Iron Flanged Table E 3" Ball Valve.
PTFE Seats with Chromed Brass Ball
and Stainless Steel Stem.



Description

A robust and reliable flanged ball valve for fitting in between Table E flanges. Body material in cast iron. PN16 Rated. Manual lever handle operated. This valve offers bubble tight shut off for a wide range of applications including Gas, Air Water and Oil.



Beschreibung

Eine robuste und zuverlässige Flansch-Kugelhahn für die Montage in der Tabelle zwischen E Flansche . Gehäusematerial aus Gusseisen. PN16 Nenn . Handhebel Handgriff betätigt . Dieses Ventil bietet blasendichte off für eine breite Palette von Anwendungen, einschließlich Gas, Luft Wasser und Öl geschlossen..







Descripción

Una válvula de bola con bridas robusto y fiable para el montaje en la Tabla E entre bridas. Material del cuerpo en hierro fundido. PN16 nominal . Palanca manual operado . Esta válvula ofrece burbuja cierre hermético para una amplia gama de aplicaciones, incluyendo Gas , Aire Agua y Aceite .



Description

Une vanne à boisseau sphérique à bride robuste et fiable pour le montage entre bridas Tableau E . Matériau du corps en fonte . PN16 nominale . Poignée de levier manuel opéré . Cette vanne offre bulle fermeture étanche pour une large gamme d'applications , y compris le gaz , l'eau et l'huile Air .

-  VOLT 3" Cast Iron Table E Ball Valve
-  VOLT 3" Cast Iron Table E - Kugelhahn
-  VOLT 3" Reparto de la Tabla válvula de bola E Hierro
-  VOLT 3" Fonte Tableau E Ball Valve

Cast Iron Ball Valve – Gas – Table E

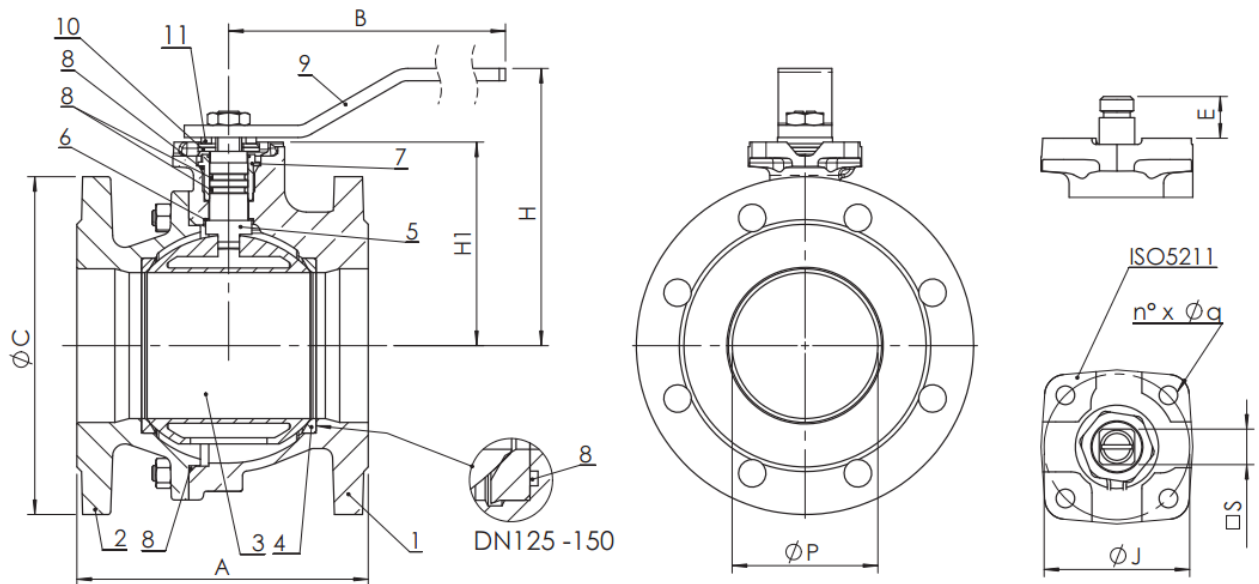

Pressure / Temperature Ratings





Pressure	16 Bar
Temperature	-10°C to +70°C

Material List

No	Name of Parts	Materials
1	Body	EN GJS 400-15
2	Flange	EN GJS 400-15
3	Ball	CuZn40Pb2 Chrome Plated Brass
4	Ball seat	Reinforced PTFE
5	Stem	CuZn40Pb2 Brass
6	Sliding Washer	PTFE
7	Ring	CuZn40Pb2 Brass
8	O-Ring	NBR
9	Lever	Carbon Steel Epoxy Coated
10	Stop Plate	Galvanised Carbon Steel
11	Spring Washer	Galvanised Carbon Steel

Dimensions

DN	P	A	H	N1	B	C	ISO	J	n X q	E	S	Kg	Nm
80	76	180	165	118	280	200	F07	70	4 X 9	20	17sq	15.5	70

-  VOLT 3" Cast Iron Table E Ball Valve
-  VOLT 3" Cast Iron Table E - Kugelhahn
-  VOLT 3" Reparto de la Tabla válvula de bola E Hierro
-  VOLT 3" Fonte Tableau E Ball Valve

Cast Iron Ball Valve – Gas – Table E

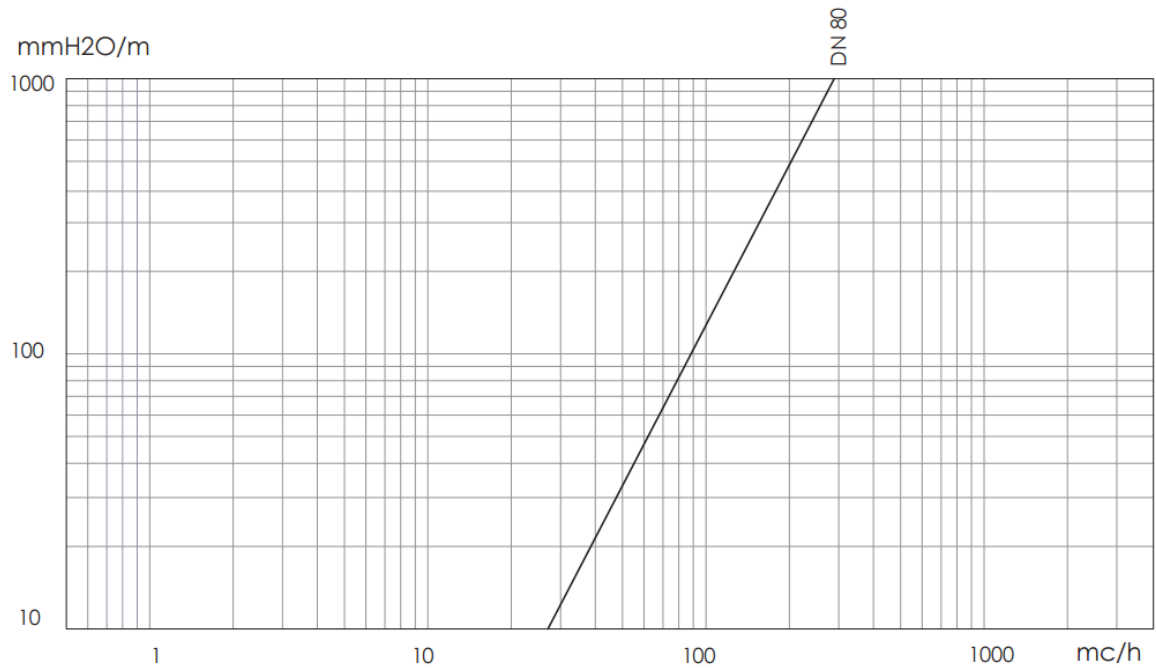

Pressure / Temperature Ratings

Pressure	16 Bar
Temperature	-10°C to +70°C



Flanged PN6/16 and
ANSI 150 Valves



3 Way Valve L & T



3 Way Diverter Valve
T and Y Ports