





-  VOLT Series Wafer Pattern Butterfly Valve - NBR Liner
-  VOLT Series Pattern Wafer Absperrklappe - NBR Liner
-  VOLT Válvula de mariposa de la serie patrón Wafer - NBR Liner
-  VOLT Série Wafer Motif vanne papillon - NBR Liner

- 1 1/2" - 24" Ductile Iron Butterfly Valve- Wafer Pattern
- 1 1/2" - 24" Ductile Iron Butterfly Ventil- Wafer Muster
- 11.2" - 24" Patrón de hierro dúctil de la mariposa Wafer Valve

Wafer Pattern Butterfly Valve- NBR Liner



GENERAL

- Lever or Gearbox Options
- 1 1/2" to 16"
- PN6/10/16, ANSI 150, Table D/E Flanges
- 18" to 24" to fit PN16 Flanges

DESCRIPTION

VOLT- General purpose wafer butterfly valve. Blue epoxy coated ductile iron body, nickel plated ductile iron disc, NBR (BUNA) liner. Notched (throttling) locking lever operator up to 12", with gearbox operation above 12". The valve has an ISO 5211 top works for direct mount of electric or pneumatic actuators. Rated PN16 up to 12" and PN10 for 14" and above, Complies with 97/23/CE (PED) Directive CE 1115



Description

A general purpose wafer butterfly valve fitted with an NBR liner, nickel plated ductile iron disc and epoxy coated ductile iron body. Suitable to fit in between flanges
PN6/10/16, ANSI 150, Table D/E. Has an ISO 5211 Top works for direct mounting. Temp -10°C to 80°C



Beschreibung

Ein Allzweck- Wafer Absperrklappe mit einem NBR -Liner ausgestattet , vernickelt Sphäroguss Scheibe und pulverbeschichtet Sphäroguss Körper. Geeignet, zwischen den Flanschen passen
PN6 / 10/16 , ANSI 150 , Tabelle D / E . Hat ein ISO 5211 Top arbeitet für Direktmontage . -10 ° C bis 80 ° C Temp







Descripción

Una válvula de mariposa de la oblea de uso general equipado con un revestimiento NBR , niquelado disco de hierro dúctil y epoxy cuerpo de hierro dúctil. Adecuado para encajar entre bridas
PN6 / 10 /16, ANSI 150 , Tabla D / E . Tiene una ISO 5211 Top trabaja para el montaje directo . Temperatura -10°C a 80°C



Description

Un but plaqueette générale papillon équipé d'un revêtement NBR , nickelé disque en fonte ductile et revêtu époxy corps fonte ductile . Convient à insérer entre brides
PN6 / 10 / 16, ANSI 150 , Tableau D / E . A une ISO 5211 Haut travaille pour un montage direct . Temp - 10°C à 80°C

-  VOLT Series Wafer Pattern Butterfly Valve - NBR Liner
-  VOLT Series Pattern Wafer Absperrklappe - NBR Liner
-  VOLT Válvula de mariposa de la serie patrón Wafer - NBR Liner
-  VOLT Série Wafer Motif vanne papillon - NBR Liner



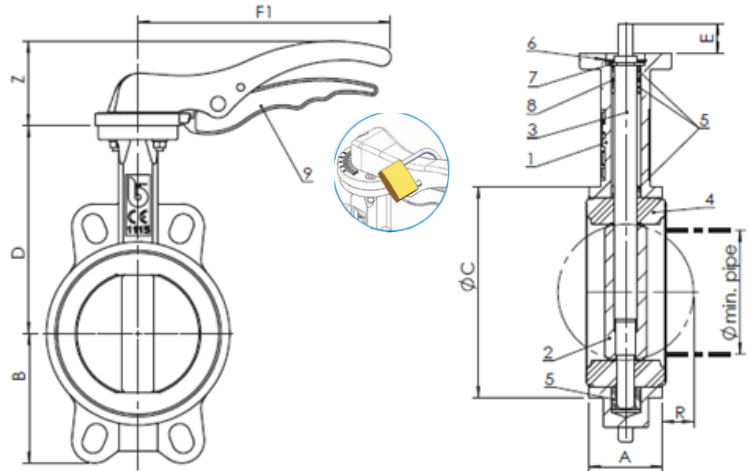

Wafer Pattern Butterfly Valve – NBR Liner

Lever or Gearbox Options
 1 1/2" to 16" to fit PN6/10/16,
 ANSI 150, Table D/E Flanges
 18" to 24" to fit PN16 Flanges



Material List	
Body	Epoxy Coated Ductile Iron
Disc	Nickel Plated Ductile Iron
Liner	NBR (BUNA)
Shaft	Stainless Steel
Bushing	PTFE
Washer	Galvanised Carbon Steel
CirClip ISO 3075	Steel
O-Ring	Viton
Lever	Aluminium up to 6" Ductile Iron 8" & Above
Bolts	Galvanised Carbon Steel

Dimensions with Lever								
SIZE	A	ØC	D	B	F1	Z	R	Ømin pipe
1 1/2"	33	82	116	63	170	50	5	27
2"	43	89	126	62	170	50	5	31
2 1/2"	46	102	136	69	170	50	9	45
3"	46	118	150	90	206	69	17	65
4"	52	150	170	106	206	69	26	90
5"	56	174	180	119	385	90	34	110
6"	56	205	200	131	385	90	50	146
8"	60	260	230	166	400	72	71	194
10"	68	318	266	202	530	72	91	241
12"	78	378	292	235	-	-	112	291
14"	78	406	335	237	-	-	128	324
16"	102	471	360	292	-	-	144	379
18"	114	539	422	318	-	-	163	428
20"	127	594	480	355	-	-	182	475
24"	154	695	562	444	-	-	219	573



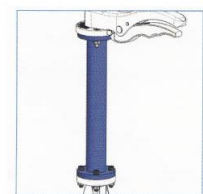
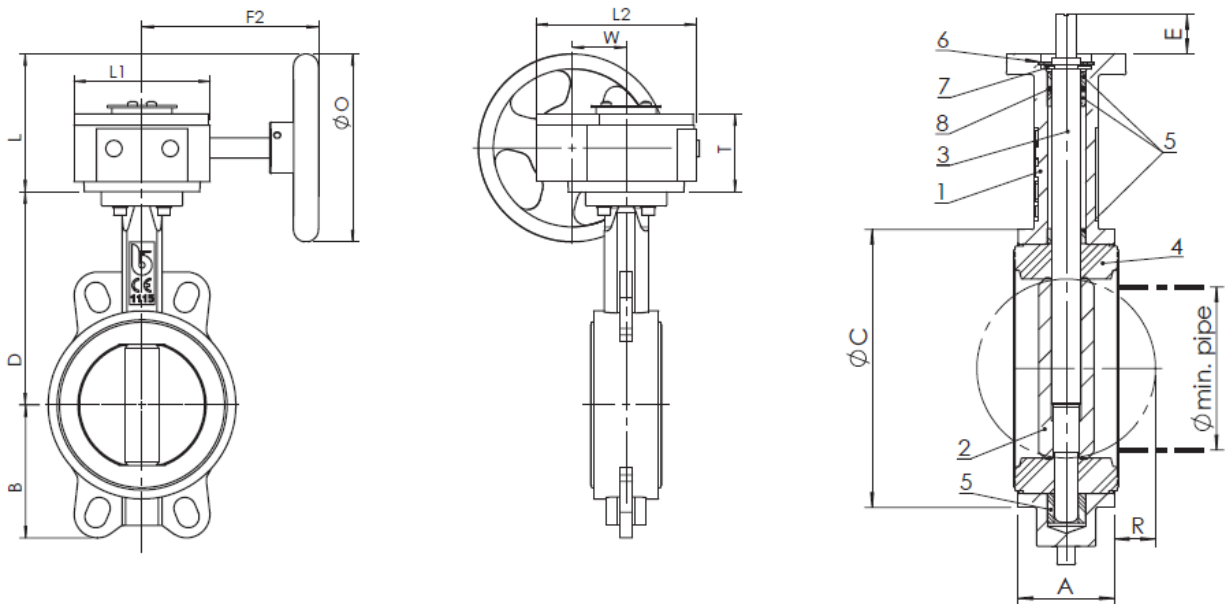

-  VOLT Series Wafer Pattern Butterfly Valve - NBR Liner
-  VOLT Series Pattern Wafer Absperrklappe - NBR Liner
-  VOLT Válvula de mariposa de la serie patrón Wafer - NBR Liner
-  VOLT Série Wafer Motif vanne papillon - NBR Liner

Wafer Pattern Butterfly Valve – NBR Liner



Extension Stem

Dimensions with Gearbox													
SIZE	A	ØC	D	B	F2	L	T	L1	L2	W	ØO	R	Ø min pipe
1 1/2"	33	82	116	63	170	102.5	65	110	130	45	150	5	27
2"	43	89	126	62	170	102.5	65	110	130	45	150	5	31
2 1/2"	46	102	136	69	170	102.5	65	110	130	45	150	9	45
3"	46	118	150	90	170	102.5	65	110	130	45	150	17	65
4"	52	150	170	106	170	102.5	65	110	130	45	150	26	90
5"	56	174	180	119	170	102.5	65	110	130	45	150	34	110
6"	56	205	200	131	170	102.5	65	110	130	45	150	50	146
8"	60	260	230	166	235	190	78	155	176	63	300	71	194
10"	68	318	266	202	226	190	80	170	195	81	300	91	241
12"	78	376	292	235	226	190	80	170	195	81	300	112	291
14"	78	406	335	257	226	190	80	170	195	81	300	128	324
16"	102	471	360	292	226	190	80	170	195	81	300	144	379
18"	114	539	422	318	216	183	80	151	188	80	285	163	428
20"	127	594	480	355	256	311	125	214	275	168	285	182	475
24"	154	695	532	444	285	386	136	262	324	293	385	219	573

-  VOLT Series Wafer Pattern Butterfly Valve - NBR Liner
-  VOLT Series Pattern Wafer Absperrklappe - NBR Liner
-  VOLT Válvula de mariposa de la serie patrón Wafer - NBR Liner
-  VOLT Série Wafer Motif vanne papillon - NBR Liner

Wafer Pattern Butterfly Valve – NBR Liner

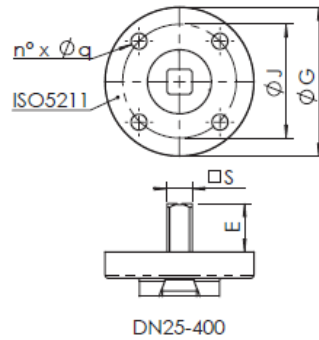

DN25-400

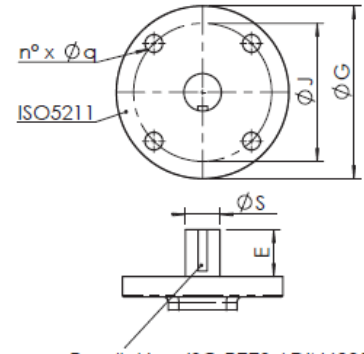

Parallel key ISO R773 / DIN6885A





DN450-600

TOP WORK / MOUNTING DETAILS

Dimensions								Weights	
SIZE	ISO	ØG	ØJ	n'xØq	□S	E	ØS	With Lever	With Gearbox
11/2"	F05	65	50	4X7	9	21		1.8	5.4
2"	F05	65	50	4X7	9	21		2.7	5.8
2 1/2"	F05	65	50	4X7	9	21		3.5	6.1
3"	F05	65	50	4X7	11	21		4	6.4
4"	F05	65	50	4X7	11	21		4.8	7
5"	F07	90	70	4X9	14	27		7.3	8.1
6"	F07	90	70	4X9	14	27		8.2	9.6
8"	F10	125	102	4X11	17	27		15	16
10"	F12	150	125	4X13	27	27		23.8	22
12"	F12	150	125	4X13	27	27		32	33
14"	F12	150	125	4X13	27	27			42
16"	F12	150	125	4X13	27	27			60
18"	F14	175	140	4X18		51.2	38		107
20"	F14	175	140	4X18		64.2	41.15		156
24"	F16	210	165	4X22		70.2	50.65		231

Pressure / Temperature

Pressure	11/2" - 12" - PN16
	14" - 24" - PN10
Temperature	NBR -10 °C to 80 °C

-  VOLT Series Wafer Pattern Butterfly Valve - NBR Liner
-  VOLT Series Pattern Wafer Absperrklappe - NBR Liner
-  VOLT Válvula de mariposa de la serie patrón Wafer - NBR Liner
-  VOLT Série Wafer Motif vanne papillon - NBR Liner



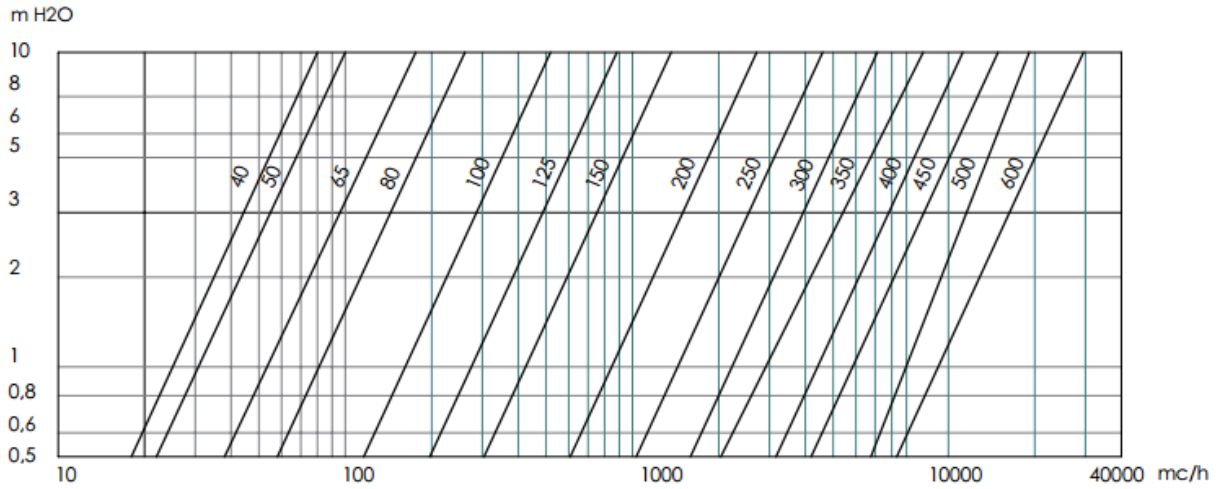

Wafer Pattern Butterfly Valve – NBR Liner

Head loss Fluid: water (1m H₂O = 0,098bar) - Head loss with shutter fully opened

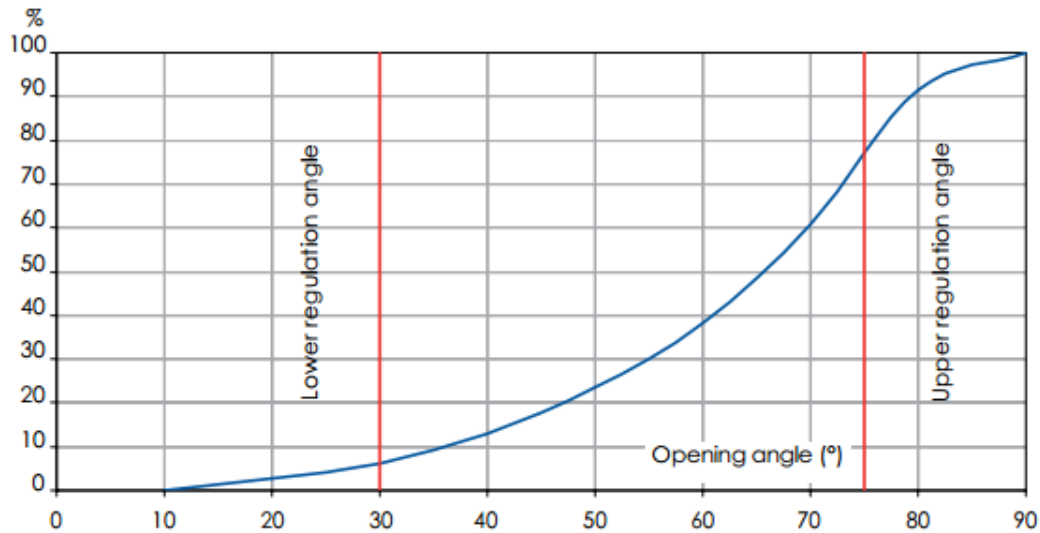

Flow rate / opening position chart Flow percentage on the flow at full opening under the same loss of head.



-  VOLT Series Wafer Pattern Butterfly Valve - NBR Liner
-  VOLT Series Pattern Wafer Absperrklappe - NBR Liner
-  VOLT Válvula de mariposa de la serie patrón Wafer - NBR Liner
-  VOLT Série Wafer Motif vanne papillon - NBR Liner

Wafer Pattern Butterfly Valve – NBR Liner

INSTALLATION AND TRANSPORT

- Keep in dry and closed place.
- While stored, the disc must be partially open (Fig. 1).
- Avoid knocks, take special care to protect lever, hand wheel, gear boxes/actuators.
- Do not use lever or hand wheel to lift the valve.

MAINTENANCE

The valve does not require maintenance.

RECOMMENDATIONS

Before carrying out maintenance or dismantling the valve, be sure that the pipes, valves and liquids have cooled down, that the pressure has decreased and that the lines and pipes have been drained in case of toxic, corrosive, inflammable or caustic liquids.

Temperatures above 50°C and below 0°C might cause damage to people.

INSTALLATION

- Handle with care.
- Do not weld the flanges to the piping after installing the valve.
- Water hammers might cause damage and ruptures. Inclination, twisting and misalignments of the piping may subject the valve to stress, once installed. It is recommended that elastic joints be used in order to reduce these effects as much as possible. The disc must be partially open (Fig. 1).

FIG. 1

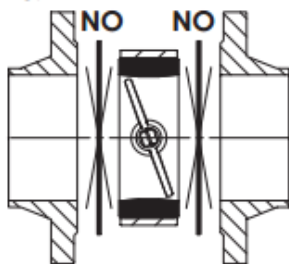

FIG. 2

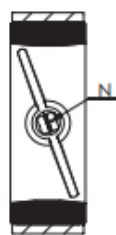
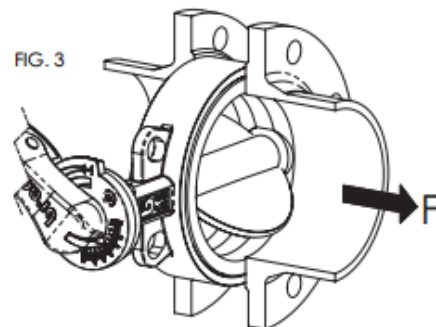

FIG. 3



The stem has a machined notch N (Fig. 2), which indicates the position of the disc; consider this indication, in order to mount the levers and actuators correctly.

The mounting can be made with the stem axis in a horizontal or vertical position. In case the fluid contains suspended solid particles (for example, sand, impurities, etc.) or solid particles that may leave deposits, it is recommended that the valve be installed with its axis horizontal, and in such a way that the bottom end of the disc opens in the direction of flow, F. (Fig. 3)

The item L9 allows the dismantling of the pipes downstream, for pressures below 6 bar. For end of line installation:

- SERIES J9 (all pressures), series L9 (pressure > 6 bar): counter flange **MUST** be installed
- SERIES L9 (pressure < 6 bar): it is recommended that a counter flange be installed.

Verify maximum working pressure and limits of use under section "maximum pressure".

Place the valve between two flanges. While placing the valve, ensure there is sufficient space in order not to damage the rubber. Do not mount seals between valve and flanges (Fig. 1). Carefully clean the contact surface. Do not install the butterfly valve in direct contact with a rubber surface (for example, expansion joints); the best installation is when the rubber is in contact with metal (Fig. 4).

In order to achieve correct working, the internal diameter of the pipe must be greater than the value indicated in the chart. Do not weld the flanges to the tube if the valve has already been installed. It is recommended that the flanges listed in the chart be used. As far as possible, avoid flat flanges for welding (EN 1092 01 type); if these flanges are used, ensure perfect centring between the flange and valve, and be sure to weld exactly edgewise to the flange. Do not let protrusions or sharp edges on the piping cause damage to the rubber surface of the valve (Fig. 5).

FIG. 4

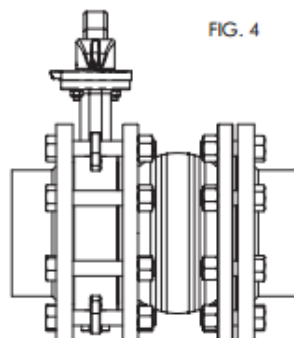
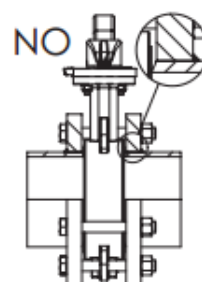





FIG. 5



-  VOLT Series Wafer Pattern Butterfly Valve - NBR Liner
-  VOLT Series Pattern Wafer Absperrklappe - NBR Liner
-  VOLT Válvula de mariposa de la serie patrón Wafer - NBR Liner
-  VOLT Série Wafer Motif vanne papillon - NBR Liner

Wafer Pattern Butterfly Valve – NBR Liner

Centre the valve on holes while using wafer type valves.
Tighten the bolts crosswise and progressively, in order to distribute the pressure equally before the body and flanges come into contact with each other. (Fig. 6)
With regard to the Lug version, check that the screws are the correct length, in order to allow complete compression of the lining rubber.
Turbulences of the fluid might increase erosion and reduce the life-cycle of the valve. Install the valve at a distance of at least 1 x DN upstream, and at a distance of 2-3 x DN downstream, away from fittings or bends.
In the open position, the valve is larger than the nominal Face to Face value.

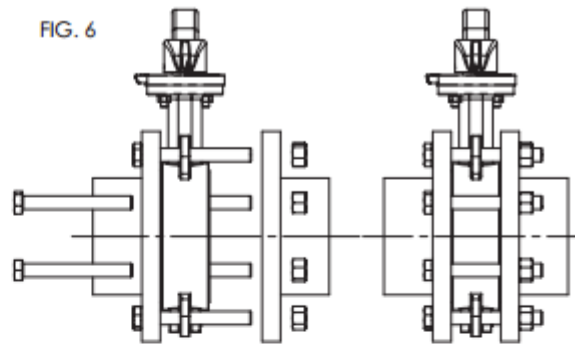

Check that no other components of the piping interfere or create damage or malfunction (Fig. 7A).
If they do, a spacer should be inserted for the valve to operate correctly (Fig. 7B).

